



中山市川狼五金制品厂

ZHONG SHAN CHUAN LANG LIGHTING CO., LTD

型号:518球场灯三头1500W

外观图



线条图

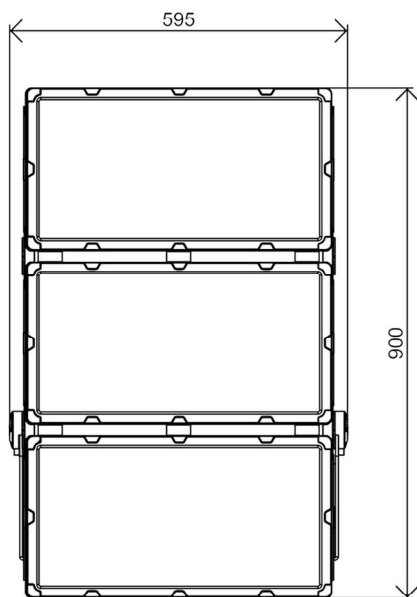

主视图

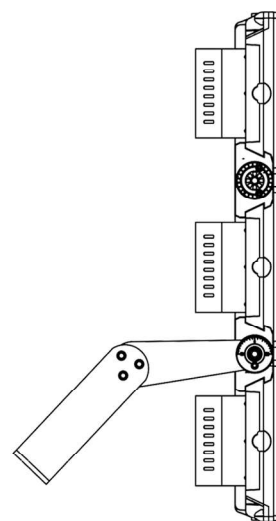

左视图

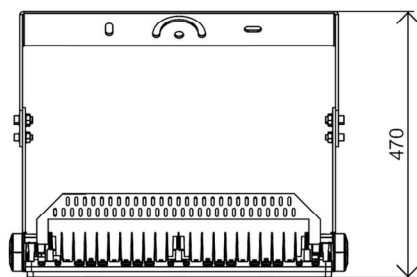

俯视图

外形尺寸:W595*L900*H470

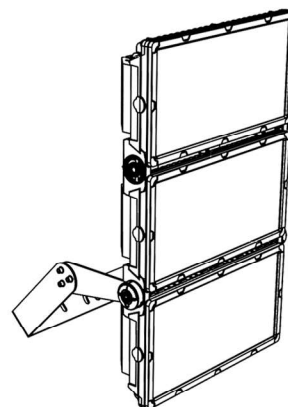

透视图

铝基板-透镜

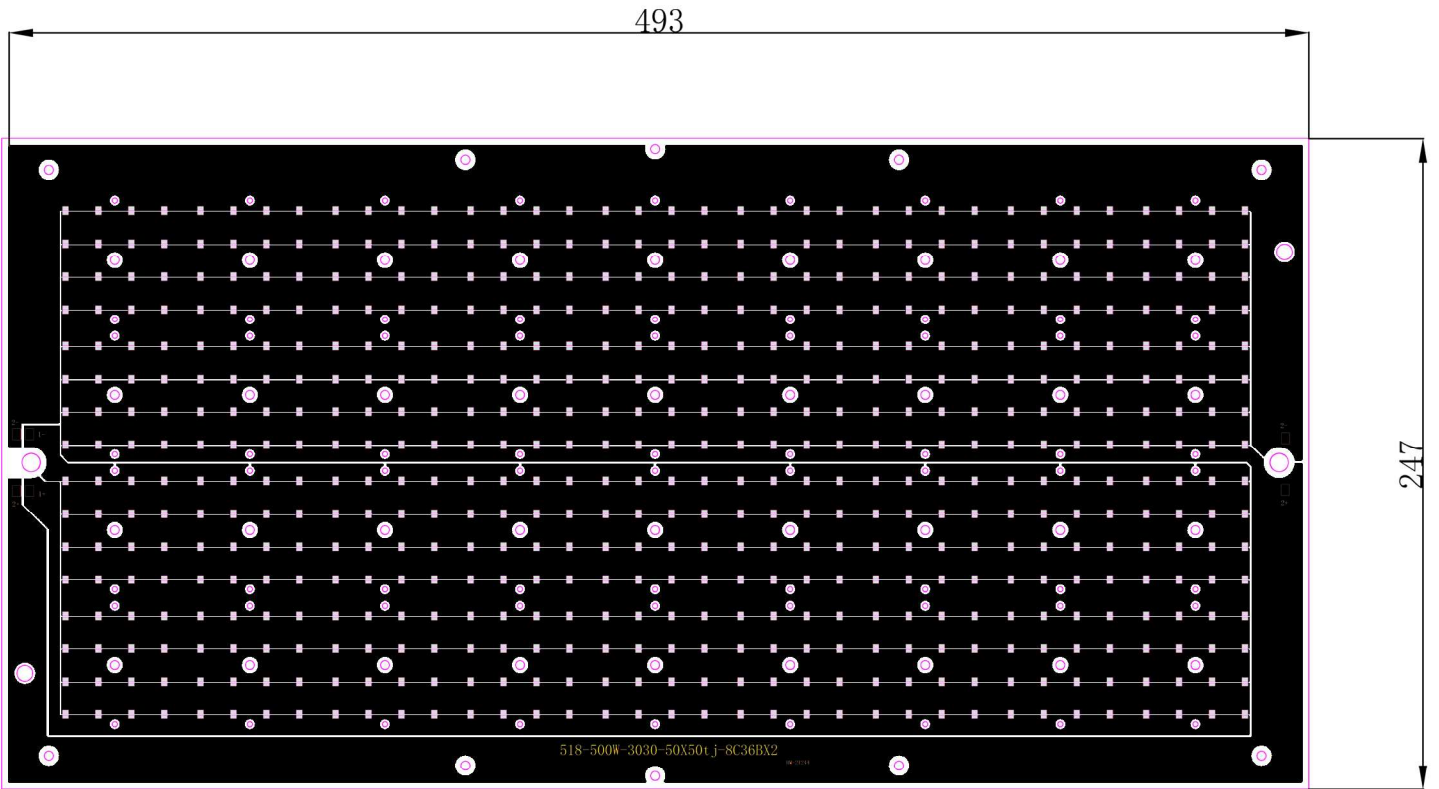

技术要求：板厚1.5mm, 导热系数2.0-3030SMD 288PCS 铜箔厚：35um
518-500W-3030-50*50tj-8c36b*2

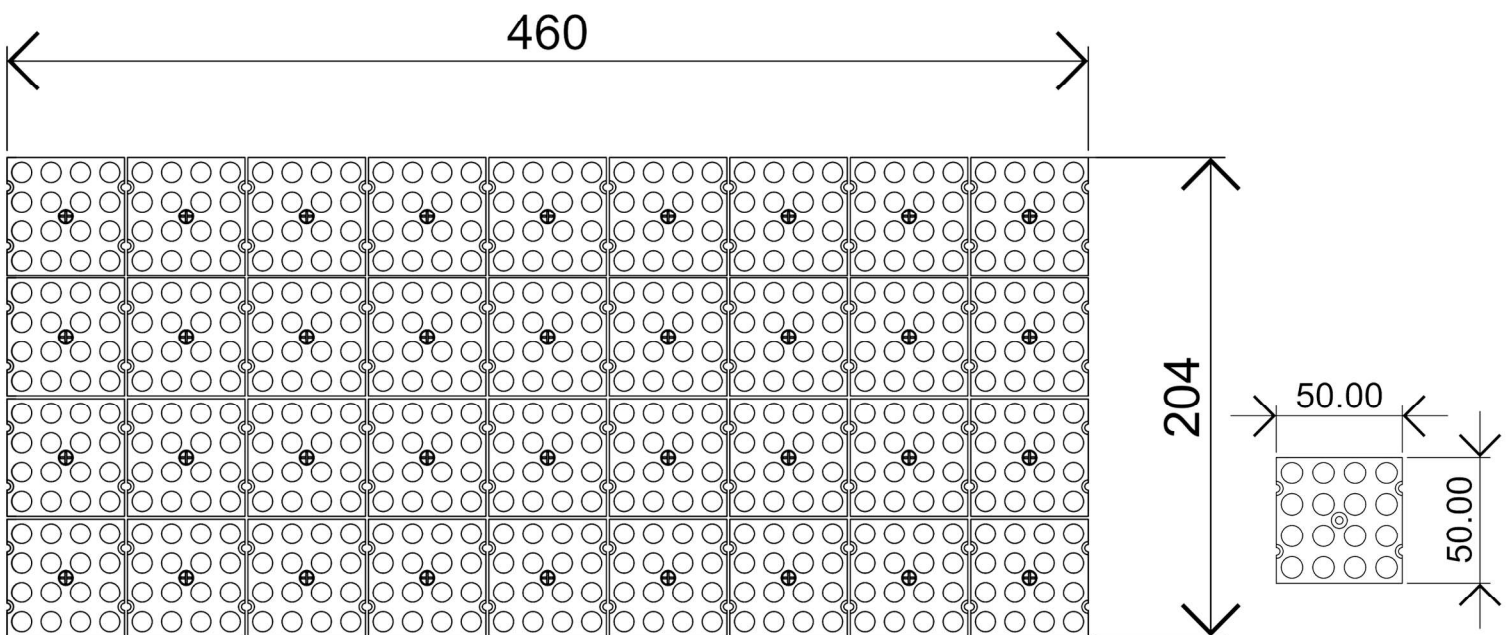

透镜:16和1透镜 50mm*50mm*H6.3mm -25度 -60度 -90度

尺寸孔位

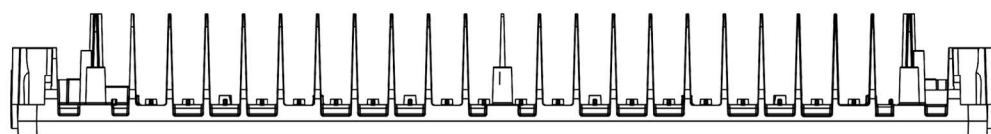
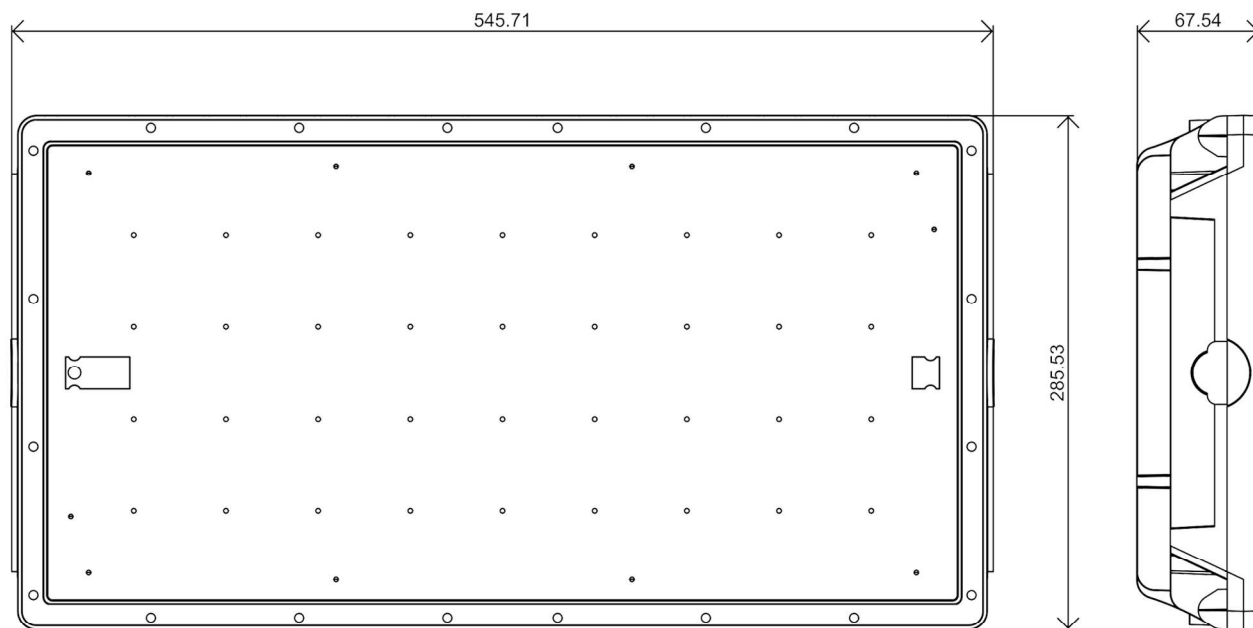

铝合金灯体重量 4.38KG

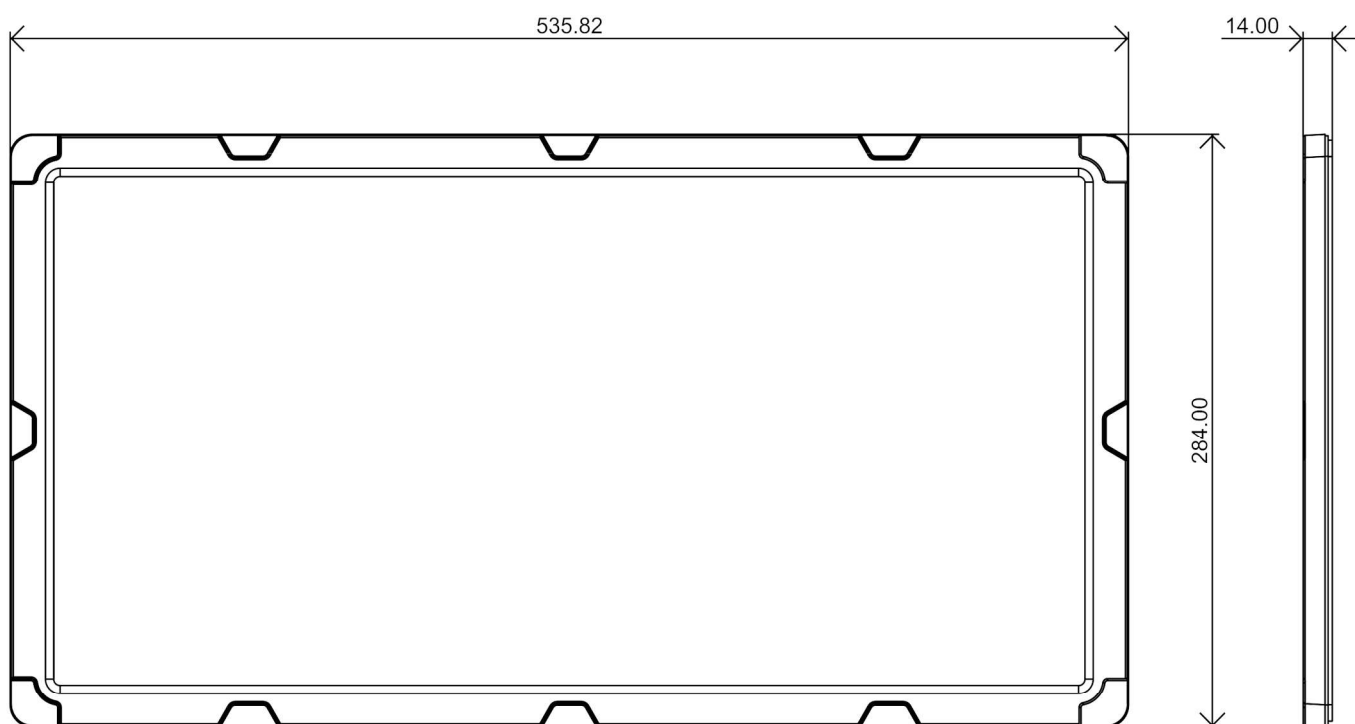

铝合金灯体面框重量 0.44KG

尺寸孔位

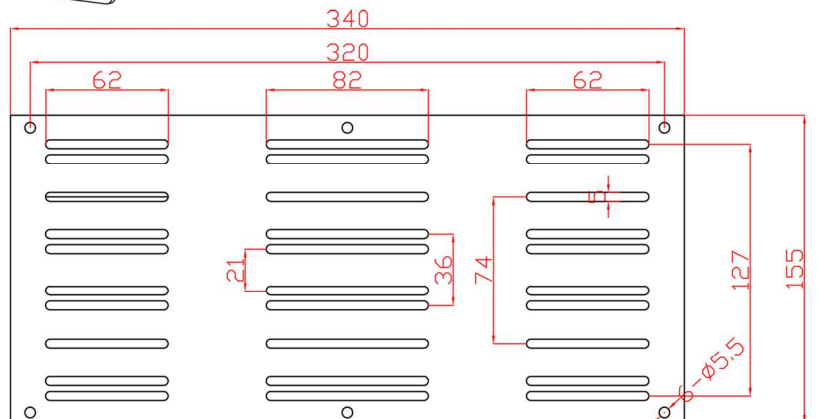
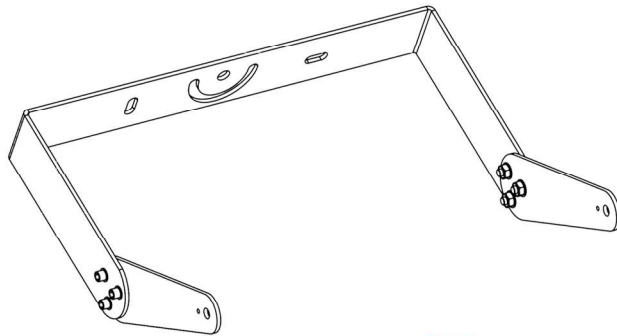
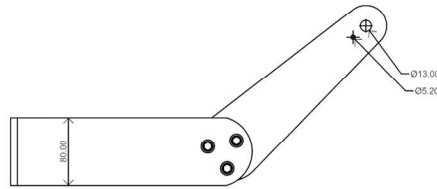
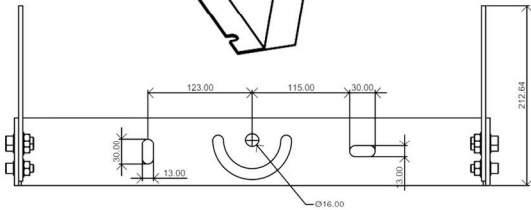
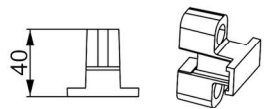
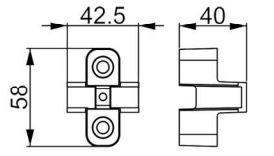
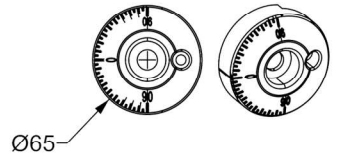
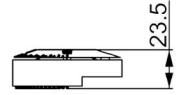
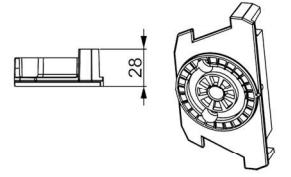
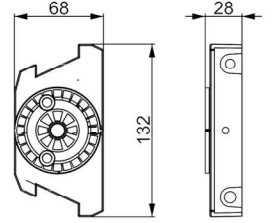
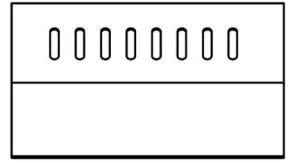
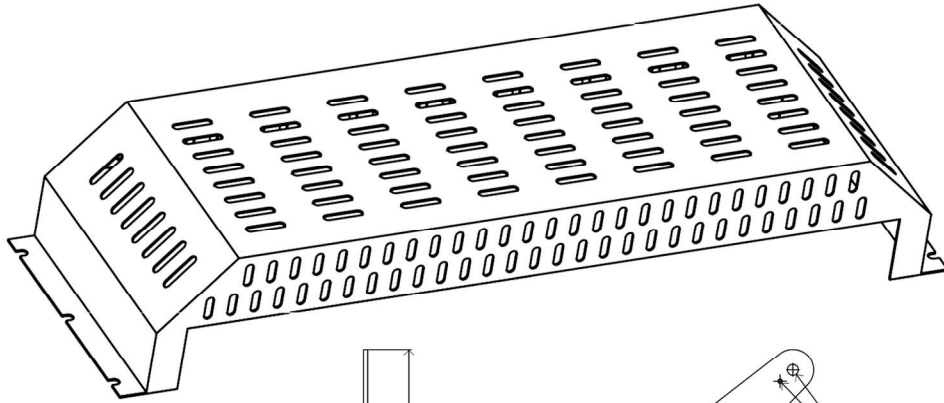
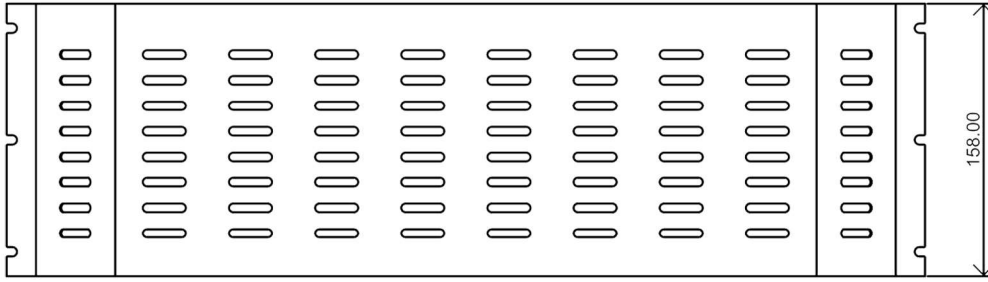
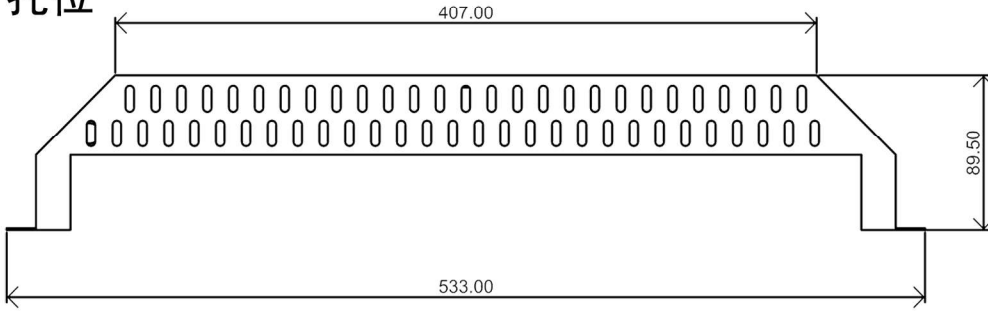

爆炸图

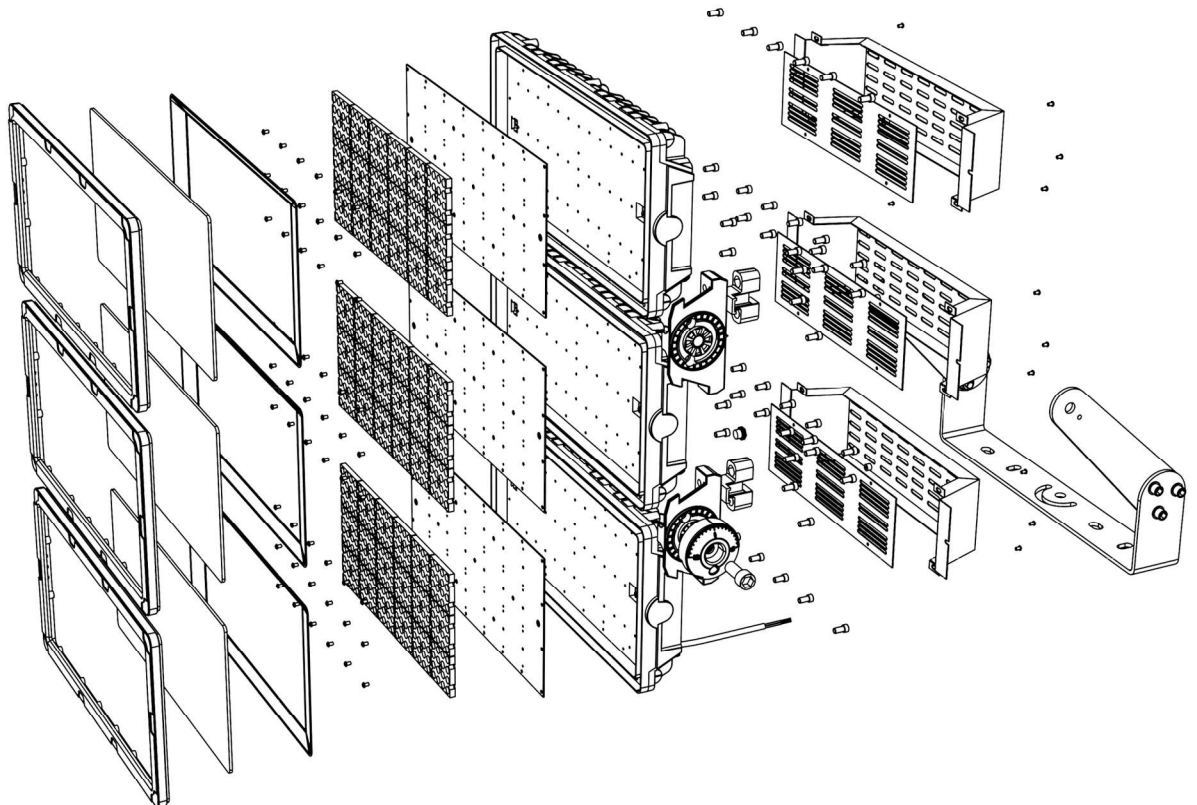
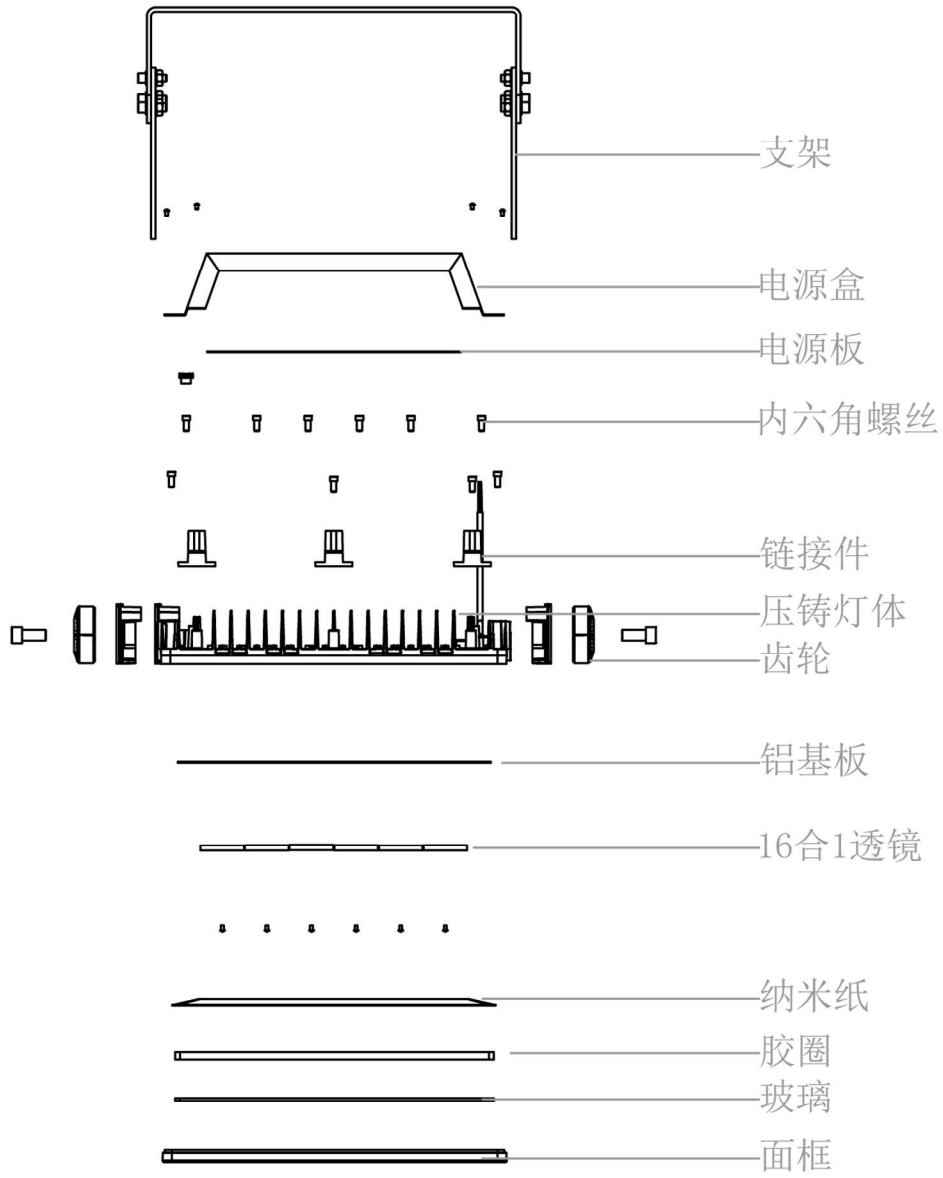

包装尺寸

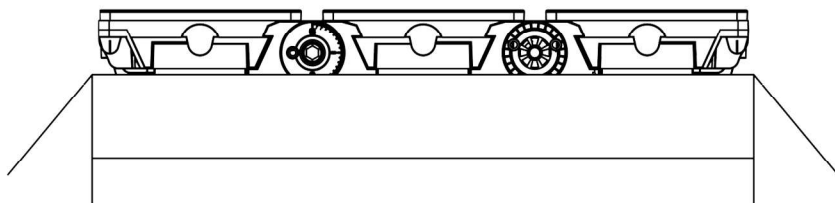
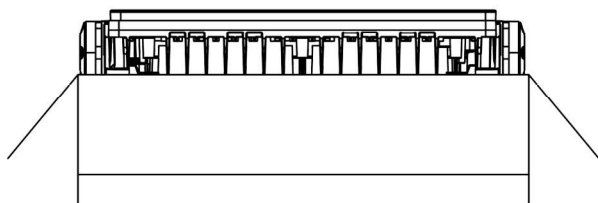
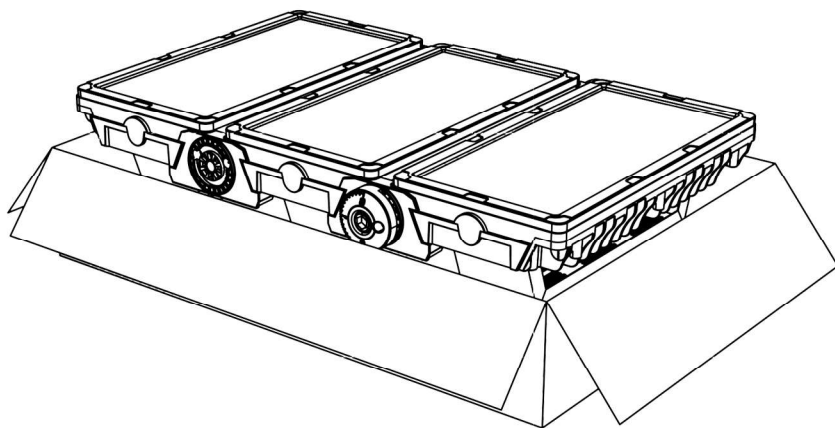
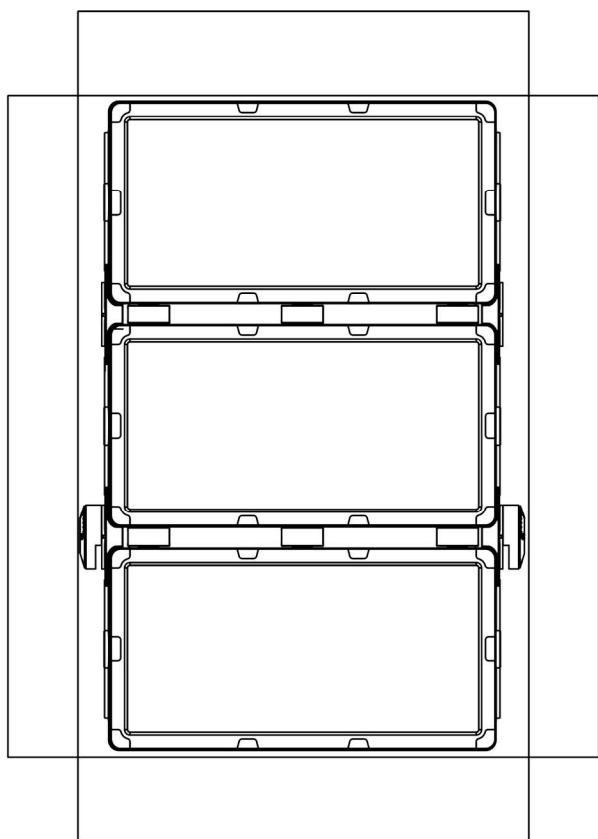

外箱尺寸：600mm*910mm*160mm